

PRODUCTS AVAILABLE FROM STOCK

COUNTERS

REFRIGERATED AND FREEZERS

30 YEARS
OF EXPERIENCE



MADE IN EU

V1 - 2021



TECHNOLOGIES IN DORA METAL COUNTERS



//Proecological refrigerant R290

It is more productive and concentrated, saves energy consumption and reduces the appliance's noise level.

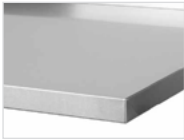

//Standard DM

Standard DM has advantages of typical flat working plate with smooth surface, easy to clean and resistant to damage. Tabletop thickness: 40 mm.



//Profiled holders

Profiled holders ensure comfort and ease of use



//High quality steel

The whole unit is made of attested high-grade stainless steels.



//Lock (option)

Possibility of mounting lock in counters with doors.



//Portable version (option)

The portable version, i.e. on swivel castors (including 2 castors with brake) can be manufactured. This applies to the undercounter refrigerators and freezers with side engine compartment.

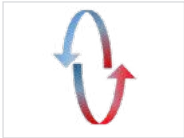

//Forced air circulation

Technology which ensures ideal temperature distribution in the chamber, in addition, forms a curtain preventing escape of cold air.



//Touch Control panel

Touch control panel with automatic ECO function and sealing in IP65 standard. Energy consumption is optimized by proper management of compressor work and fans in cooling system



//Adjustable stainless steel feet

Thanks to +20/-40mm regulation you can adjust counter's height to your needs.



//Dust filter (option)

The condenser's dust filter separates solid particles from air protecting the condenser.

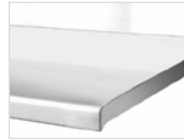

//Standard DM-S

Standard DM -S is equipped with high anti-splash back edge (H=100 mm) and gently rounded front edge with a „throat” protecting bodies of products. Both elements ensure higher hygiene standards. Tabletop thickness: 50 mm.



//Gaskets

Easy to replace magnetic gaskets.

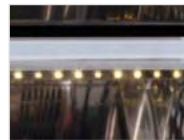

//LED Lighting (option)

The used light is characterised by high reliability which results directly in energy saving and ensures proper illumination of chamber interior



//Automatic condensate evaporation

Automatic condensate evaporation after evaporator defrosting cycle - ensure maintenance free operation of equipment.



//Monitoring (option)

Remote monitoring of equipment operation.

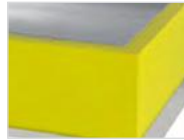

//Insulation

Injected polyurethane insulation is based on 4th generation frother – Hydrofluoroolefin product invented in USA. It's environmental friendly and 10-12% more efficient than traditionally used cyclopentane.



//Easy change of DIRECTION of door opening







The design allows changing the direction of the door opening so that the product can be adapted to own specific requirements.



//Door with self-closing device

Special construction of hinge makes that you don't have to remember about closing the door.

VERSIONS OF REFRIGERATED AND FREEZER COUNTERS

	DOOR	TYPE	REFRIGERATED COUNTERS (NUMBER OF COMPARTMENTS)				FREEZER COUNTERS (NUMBER OF COMPARTMENTS)		
									
Built-in cooling	solid	Standard	•	•	•	•	•	•	•
		With sink	-	•	•	•	-	-	-
		For bakeries	-	•	•	-	-	-	-
		For preparing pizza	-	•	•	-	-	-	-
	glass	Standard	•	•	•	•	-	-	-
		With sink	-	•	•	•	-	-	-
For remote cooling	solid	Standard	-	•	•	•	-	•	•
		For bakeries	-	•	•	-	-	-	-
	glass	Standard	-	•	•	•	-	-	-

"-" - not available

"•" - available

HIGH DYNAMICS AND EXCELLENT AIR DISTRIBUTION FRESHNESS AT YOUR FINGERTIPS

HIGH DYNAMICS OF COOLING AND FREEZING

Due to their role refrigerated and freezer counters are frequently opened. It causes frequent rises of temperature and risk of loss of freshness of groceries. Thanks to high dynamics of cooling systems refrigerated and freezer counters Dora Metal ensure that all groceries will stay fresh even with door opened frequently. This ability ensures also quick cooling and freezing of newly inserted items which is also crucial for their freshness and safety.

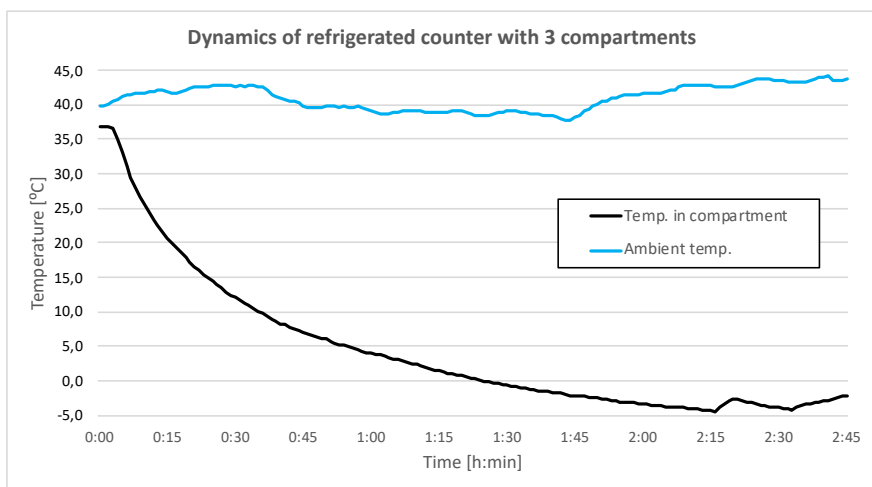

- chilling time 1h12min from +37°C to +2°C
- 5 climatic class (+40°C)

Dynamics of refrigerated counter with 3 compartments

Proper conditions in the whole volume, excellent ventilation

Forced airflow ensures proper temperature conditions in the whole volume of compartments and quick cooling down of newly inserted groceries. Thanks to efficient cooling system and powerful fans temperature is even more stable and cooling process faster. It's especially important for keeping groceries fresh longer.

Construction of counters enables placing them in a row (built-in from both sides) without any loss to their working parameters. For proper ventilation of cooling system appliance uses only perforation in front part.

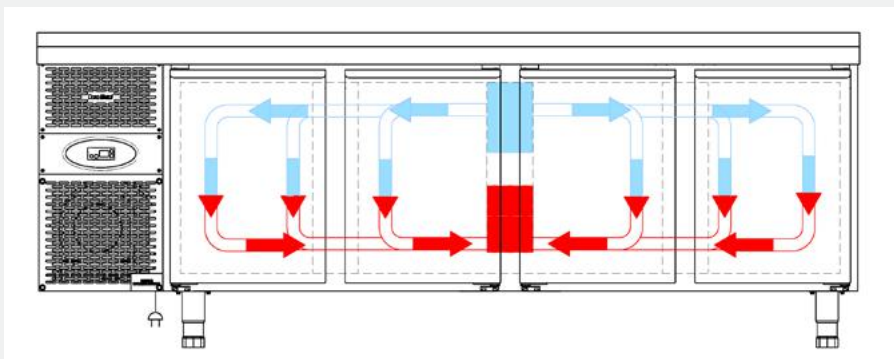

HOW TO READ ENERGY LABEL AND WHY THIS IS IMPORTANT?

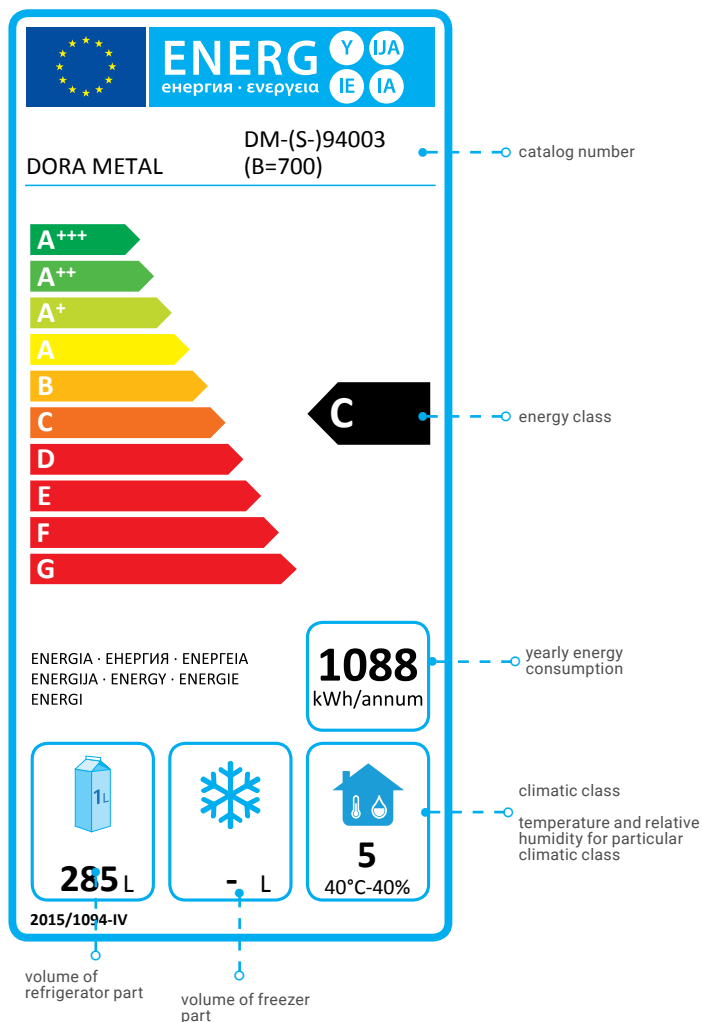

Energy label is very important set of information about performance of given cooling appliance. This is not only obligatory element of appliance's documentation required by EU law but also information about climate conditions in which our product can work and how much it will cost us. Climatic class shows in which conditions appliance will be in line with requirements described in EU standards (higher class means more powerful appliance). Energy class shows if appliance is energy-efficient. Below example shows how energy class directly influences cost of maintenance. This is investment in our lower bills and pro-ecological activity for clean environment around us.

Refrigerated counter 3-compartments



Cost of energy* (net)
Energy consumption
Model
Saving vs. class D



€ 294 / year
1088 kWh / year
Dora Metal DM-94003
€ 87 / year



€ 381 / year
1472 kWh / year
Counter in D class

Freezer counter 3-compartments



Cost of energy* (net)
Energy consumption
Model
Saving vs. class E



€ 720 / year
2665 kWh / year
Dora Metal DM-95003
€ 281 / year



€ 1001 / year
3706 kWh / year
Counter in E class

*taken cost €0,27net for 1kWh

WE DESIGN ECOLOGICAL PRODUCTS FOR BETTER ENVIRONMENT AROUND US

Care about natural environment is the biggest challenge for us in next years. New refrigerated and freezer counters are based on ecological cooling agent R290, efficient and eco-friendly. Choose responsibly and focus on ecology - this is the best investment.

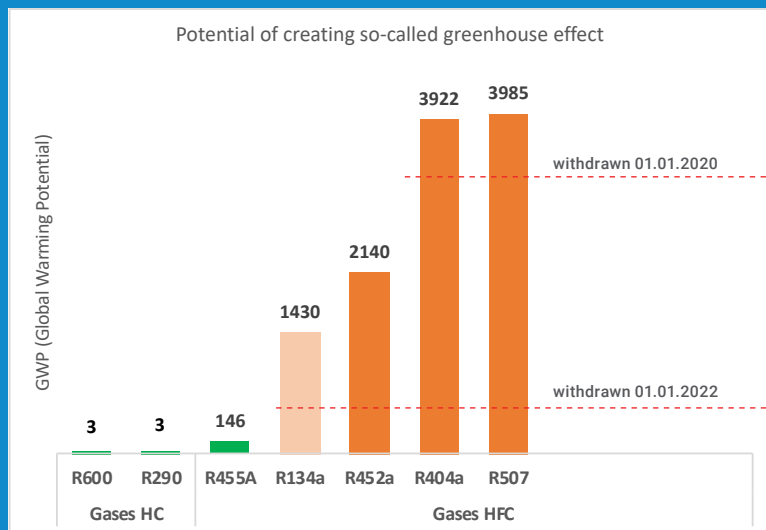

EASY SERVICE TECHNOLOGY

Counters with side engine compartment are equipped with **EASY SERVICE** technology which significantly simplifies maintenance of appliance. Front grill can be easily disassembled without tools and pull out the whole aggregate module, giving access to it from both sides. All this is available without moving counter from its working position. It simplifies maintenance and saves time - these are measurable benefits for customer.

EASY SERVICE package includes also replaceable magnetic gaskets in doors.



CAPACIOUS DRAWER MODULES

Drawer modules in Dora Metal counters offer wide range of options giving possibility to adapt product to your needs.

Big drawer module is a real capacity master - can store even a big case of beer (case dimension 400x300mm). High bearing capacity of drawers and high quality sliders will prove their reliability in every situation and will ensure long and trouble-free operation.

Our modules are designed based on the highest quality sliders which have been approved by NSF certificate (National Sanitation Foundation). It means that they meet the highest requirements for products in gastronomy business.

Drawer slides with NSF certificate

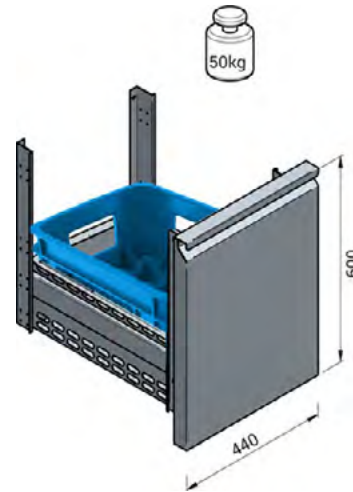

One perforated drawer dedicated for bottles or container:

- for B=700mm - 1/1 GN h=200mm
- for B=600mm - 2/3 GN h=200mm

(h=100mm in case of refrigerated counters with bottom engine compartment: DM-94044, DM-S-94044, DM-90044, DM-S-90044)

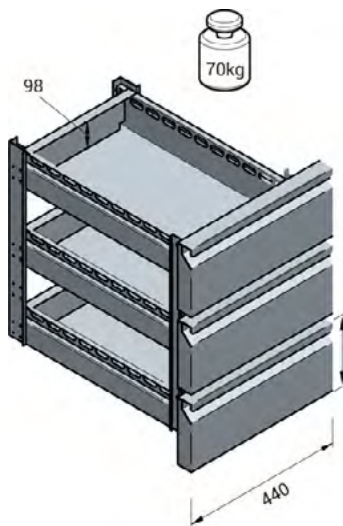

Three perforated drawers dedicated for GN container:

- for B=700mm - 1/1 GN h=200mm
- for B=600mm - 2/3 GN h=200mm

(only for counters with side engine compartment)

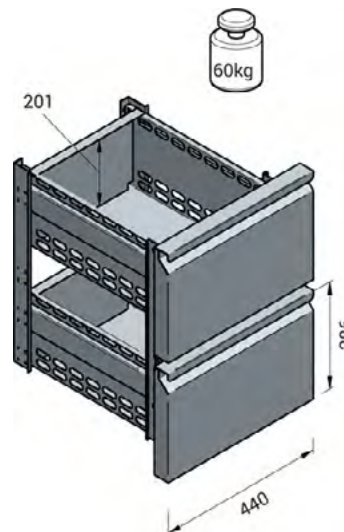

Two perforated drawers dedicated for GN container:

- for B=700mm - 1/1 GN h=200mm
- for B=600mm - 2/3 GN h=200mm

(h=100mm in case of refrigerated counters with bottom engine compartment: DM-94044, DM-S-94044, DM-90044, DM-S-90044)

You already have Dora Metal counter and want to replace door with drawers?? Nothing more simple! Well thought-out design and intuitive assembling enables replacing modules by customer. Ask one of our sales representatives for details. This option is available in counters with side engine compartment.



SMART DESIGN - WE CARE ABOUT DETAILS

Counter top protrusion and legs adjusted to floor plinths

While designing professional gastronomy appliances it should be taken under consideration that assembling at customer's premises not always runs smoothly. Walls not always are straight and smooth and floor plinths not always are on drawings of kitchen. Construction of Dora Metal counters is ready for such situations.

Protruding of counter's top allows to "bypass" some pipes or other installations standing-out from walls.

Proper position of legs allows to avoid collisions with floor plinths. In such case we save customer's time who may focus on quicker launching his business.

Dora Metal counters have one more useful feature. After dismantling legs the bottom part of appliance is flat - it can be placed on concrete socle.

Counters with side engine compartment

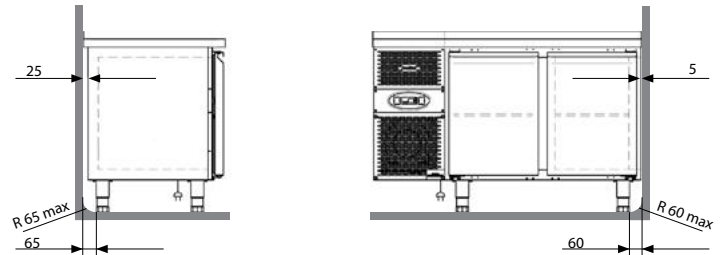

Counters with bottom engine compartment

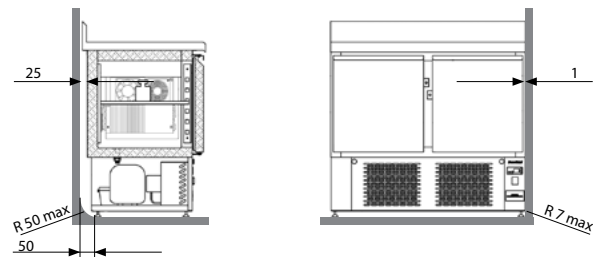

Drawers over-extension >100% - possibility to insert GN container with liquid

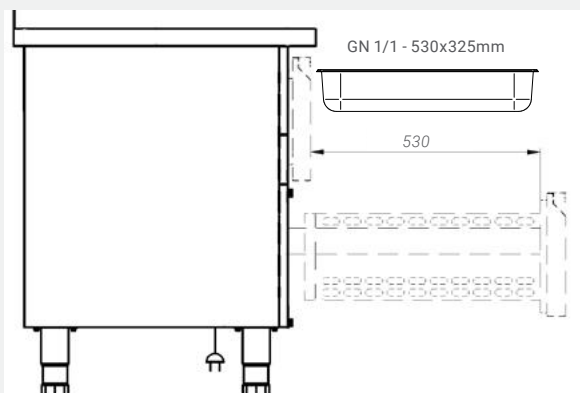

Drawers in refrigerated and freezer counters are not only capacious and very durable - they offer also higher convenience of use

Drawer can be pulled-out further than its total length. It gives more comfortable access to groceries and offers unique possibility of placing GN container holding it horizontally.

REFRIGERATED COUNTERS WITH SOLID DOOR

Refrigerated counters Dora Metal play a role of handy storeroom of groceries. Reliable construction, high quality of materials and very good performance will satisfy most demanding customers.



DM-94003
DM-S-94003 (fot)

MODELS WITH BUILT-IN COOLING

		DM-94044	DM-94002	DM-94003	DM-94004
		DM-S-94044	DM-S-94002	DM-S-94003	DM-S-94004
Number of compartments					
Position of engine compartment					
Dimensions WxDxH [mm]	B=600 B=700	950x600x850 950x700x850	1325x600x850 1325x700x850	1825x600x850 1825x700x850	2325x600x850 2325x700x850
Refrigerant		R290	R290	R290	R290
Energy class		C	C	C	C
Climatic class		5	5	5	5
Volume [net/gross] L	B=600 B=700	96/130 144/170	126/190 190/220	189/285 285/330	252/380 380/440
Compartment suitable for	B=600 B=700	cont. 2/3 GN cont. 1/1 GN	cont. 2/3 GN cont. 1/1 GN	cont. 2/3 GN cont. 1/1 GN	cont. 2/3 GN cont. 1/1 GN
Energy consumption	B=600 B=700	868kWh 978kWh	868kWh 978kWh	978kWh 1088kWh	1198kWh 1289kWh
Temp. range		-2...+10°C	-2...+10°C	-2...+10°C	- 2...+10°C
Cooling power		605W	605W	605W	605W
Power supply		297W/230V	297W/230V	297W/230V	297W/230V

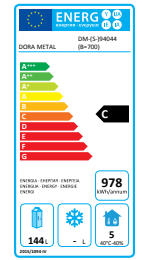
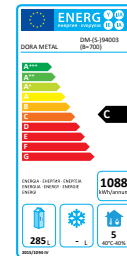

DM-94044
DM-S-94044 (fot)

Special construction of counters allow them to work in installations with remote cooling. Such solution allows to decrease noise level and temperature what makes work more comfortable and efficient.

MODELS FOR REMOTE COOLING

		DM-90044	DM-90002	DM-90003	DM-90004
		DM-S-90044	DM-S-90002	DM-S-90003	DM-S-90004
Number of compartments					
Position of engine compartment					
Dimensions WxDxH [mm]	B=600 B=700	950x600x850 950x700x850	1125x600x850 1125x700x850	1625x600x850 1625x700x850	2125x600x850 2125x700x850
Cooling power		605W	605W	605W	605W
Climatic class		5	5	5	5
Temp. range		-2...+10°C	-2...+10°C	-2...+10°C	-2...+10°C
Power supply		62W/230V	62W/230V	62W/230V	62W/230V



DM-S-90003
DM-S-90003 (fot)







Recommended refrigerant for models for remote cooling

R290

FREEZER COUNTERS WITH SOLID DOOR

Freezer counters Dora Metal play a role of handy storeroom of groceries. Reliable construction, high quality of materials and very good performance will satisfy most demanding customers.





MODELS WITH BUILT-IN COOLING

		DM-95044 DM-S-95044	DM-95002 DM-S-95002	DM-95003 DM-S-95003
Number of compartments				
Position of engine compartment				
Dimensions WxDxH [mm]	B=600 B=700	950x600x850 950x700x850	- 1325x700x850	- 1825x700x850
Refrigerant		R290	R290	R290
Energy class		D	D	D
Climatic class		4	5	5
Volume [net/gross] L	B=600 B=700	96 / 130 145 / 170	- 190 / 220	- 285 / 330
Compartment suitable for	B=600 B=700	cont. 2/3 GN cont. 1/1 GN	- cont. 1/1 GN	- cont. 1/1 GN
Energy consumption	B=600 B=700	2125kWh 2375kWh	- 2380kWh	- 2665kWh
Temp. range		-14...-21°C	-14...-21°C	-14...-21°C
Cooling power		495W	495W	495W
Power supply		511W/230V	511W/230V	511W/230V



Special construction of counters allow them to work in installations with remote cooling. Such solution allows to decrease noise level and temperature what makes work more comfortable and efficient.

MODELS FOR REMOTE COOLING

		DM-90502 DM-S-90502	DM-90503 DM-S-90503
Number of compartments			
Position of engine compartment			
Dimensions WxDxH [mm]		1125x700x850	1625x700x850
Cooling power		495W	495W
Climatic class		5	5
Temp. range		-14...-21°C	-14...-21°C
Power supply		102W / 230V	102W / 230V



Recommended refrigerant for models for remote cooling
R290

COMPACT REFRIGERATED AND FREEZER COUNTERS



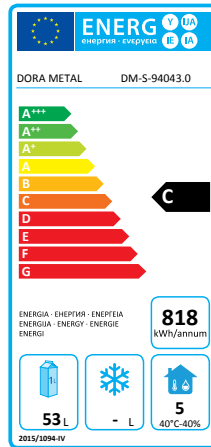

Small 1-compartment counters are perfect supplement of kitchen equipment. Thanks to compact size (only 50cm width) and great performance they will fit in smallest kitchens and become handy storeroom of fresh groceries.

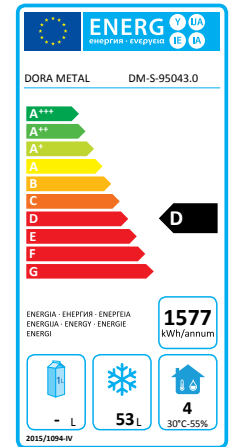

DM-S-94043.0
DM-S-95043.0



DM-S-94043.0 DM-S-94043.2 DM-S-93043 DM-S-95043.0 DM-S-95043.2

Door version					
Counter type	refrigerated	refrigerated	refrigerated	freezer	freezer
Door type	solid	drawers	glass	solid	drawers
Dimensions WxDxH [mm]	500x530x890	500x530x890	500x530x890	500x530x890	500x530x890
Refrigerant	R290	R290	R290	R290	R290
Energy class	C	D	C	D	D
Climatic class	5	4	5	4	4
Volume [net/gross] L	53 / 80	36 / 80	53 / 80	53 / 80	36 / 80
Compartment suitable for	shelf 362x280mm	1/2 GN h=150 2/3 GN h=150	shelf 362x280mm	shelf 362x280mm	1/2 GN h=150 2/3 GN h=150
Energy consumption	818kWh	1051kWh	818kWh	1577kWh	1577kWh
Temp. range	-2...+10°C	-2...+10°C	-2...+10°C	-14...-21°C	-14...-21°C
Cooling power	322W	322W	322W	232W	232W
Power supply	210W/230V	210W/230V	210W/230V	301W/230V	301W/230V

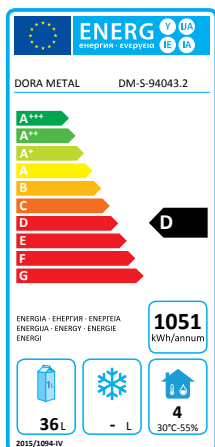

DM-S-94043.2
DM-S-95043.2

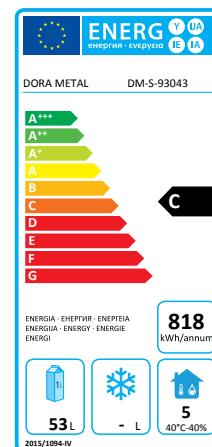
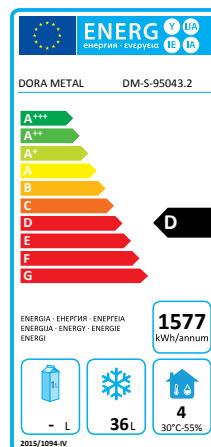





DM-S-93043

REFRIGERATED COUNTERS FOR BAKERIES

Refrigerated counters Dora Metal play a role of handy storeroom of groceries. Reliable construction, high quality of materials and very good performance will satisfy most demanding customers.

MODELS WITH BUILT-IN COOLING

	DM-94001 DM-S-94001	DM-94007 DM-S-94007
Number of compartments		
Position of engine compartment		
Dimensions WxDxH [mm]	1475x800x850	2050x800x850
Refrigerant	R290	R290
Energy class	C	C
Climatic class	5	5
Volume [net/gross] L	276 / 300	414 / 450
Compartment suitable for	trays 400x600	trays 400x600
Energy consumption	1174kWh	1314kWh
Temp. range	+2...+10°C	+2...+10°C
Cooling power	605W	605W
Power supply	297W/230V	297W/230V





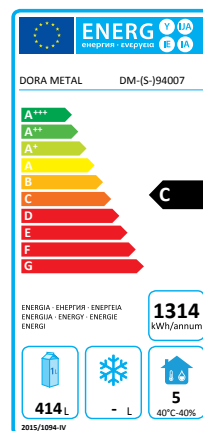

DM-94007
DM-S-94007 (fot)



Special construction of counters allow them to work in installations with remote cooling. Such solution allows to decrease noise level and temperature what makes work more comfortable and efficient.

MODELS FOR REMOTE COOLING

	DM-90401 DM-S-90401	DM-90407 DM-S-90407
Number of compartments		
Position of engine compartment		
Dimensions WxDxH [mm]	1275x800x850	1850x800x850
Cooling power	605W	605W
Climatic class	5	5
Temp. range	+2...+10°C	+2...+10°C
Power supply	62W / 230V	62W / 230V



DM-90407
DM-S-90407 (fot.)



Recommended refrigerant for
models for remote cooling

R290

REFRIGERATED COUNTERS WITH GLASS DOOR

Refrigerated counters Dora Metal play a role of handy storeroom of groceries. Reliable construction, high quality of materials and very good performance will satisfy most demanding customers.

MODELS WITH BUILT-IN COOLING

	DM-94005 DM-S-94005	DM-94006 DM-S-94006	DM-94008 DM-S-94008	
Number of compartments				
Dimensions WxDxH [mm]	B=600 B=700	1325x600x850 1325x700x850	1825x600x850 1825x700x850	2325x600x850 2325x700x850
Refrigerant	R290	R290	R290	
Energy class	C	C	D	
Climatic class	4	4	4	
Volume [net/gross] L	B=600 B=700	126 / 190 190 / 220	189 / 285 285 / 330	252 / 380 380 / 440
Compartment suitable for	B=600 B=700	cont. 2/3 GN cont. 1/1 GN	cont. 2/3 GN cont. 1/1 GN	cont. 2/3 GN cont. 1/1 GN
Energy consumption	B=600 B=700	955kWh 1075kWh	1075kWh 1196kWh	1317kWh 1382kWh
Temp. range		+2...+10°C	+2...+10°C	+2...+10°C
Cooling power		605W	605W	605W
Power supply		297W/230V	297W/230V	297W/230V



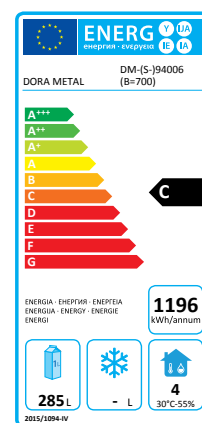

DM-94006
DM-S-94006 (fot)



Special construction of counters allow them to work in installations with remote cooling. Such solution allows to decrease noise level and temperature what makes work more comfortable and efficient.

MODELS FOR REMOTE COOLING

	DM-90005 DM-S-90005	DM-90006 DM-S-90006	DM-90008 DM-S-90008	
Number of compartments				
Dimensions WxDxH [mm]	B=600 B=700	950x600x850 950x700x850	1125x600x850 1125x700x850	1625x600x850 1625x700x850
Cooling power		605W	605W	605W
Climatic class		5	5	5
Temp. range		+2...+10°C	+2...+10°C	+2...+10°C
Power supply		62W/230V	62W/230V	62W/230V



DM-90005
DM-S-90005 (fot)







Recommended refrigerant for models for remote cooling

R290

REFRIGERATED COUNTERS WITH SINK

Refrigerated counters Dora Metal play a role of handy storeroom of groceries. Reliable construction, high quality of materials and very good performance will satisfy most demanding customers.

MODELS WITH BUILT-IN COOLING

	DM-91002	DM-91003	DM-91004	DM-91005	DM-91006	DM-91008
	DM-S-91002	DM-S-91003	DM-S-91004	DM-S-91005	DM-S-91006	DM-S-91008
Number of compartments						
Door type	solid			glass		
Dimensions WxDxH [mm]	B=600 B=700	1325x600x850 1325x700x850	1825x600x850 1825x700x850	2325x600x850 2325x700x850	1325x600x850 1325x700x850	1825x600x850 1825x700x850
Refrigerant	R290			R290		
Energy class	C			C		
Climatic class	5			4		
Volume [net/gross] L	B=600 B=700	126 / 190 190 / 220	189 / 285 285 / 330	252 / 380 380 / 440	126 / 190 190 / 220	189 / 285 285 / 330
Compartment suitable for	B=600 B=700	cont. 2/3 GN cont. 1/1 GN	cont. 2/3 GN cont. 1/1 GN	cont. 2/3 GN cont. 1/1 GN	cont. 2/3 GN cont. 1/1 GN	cont. 2/3 GN cont. 1/1 GN
Energy consumption	B=600 B=700	868kWh 978kWh	978kWh 1088kWh	1198kWh 1289kWh	955kWh 1075kWh	1075kWh 1196kWh
Temp. range	-2...+10°C			-2...+10°C		
Cooling power	605W			605W		
Power supply	297W/230V			297W/230V		

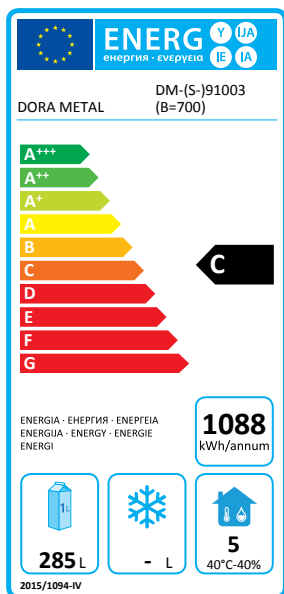

DM-91003 (fot)
DM-S-91003

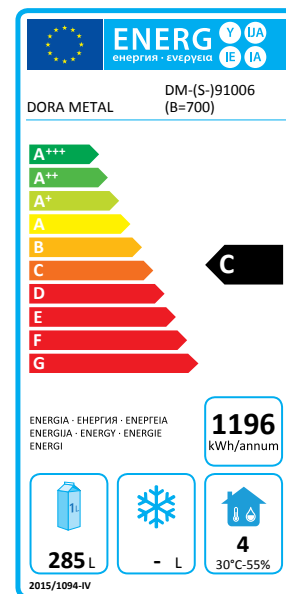







DM-91006 (fot)
DM-S-91006

REFRIGERATED COUNTERS FOR PREPARING PIZZA

Refrigerated counters Dora Metal play a role of handy storeroom of groceries. Reliable construction, high quality of materials and very good performance will satisfy most demanding customers.

MODELS WITH BUILT-IN COOLING

	DM-94042 DM-S-94042	DM-94048 DM-S-94048	DM-94051	DM-94049
Number of compartments				
Position of engine compartment				
Dimensions WxDxH [mm]	950x700x850/1120	1475x800x850/1030	1475x800x840/1000	1975x800x840/1000
Refrigerant	R290	R290	R290	R290
Energy class	C	C	C	C
Climatic class	4	4	5	5
Volume [net/gross] L	144 / 170	276 / 300	276 / 300	276 / 300
Compartment suitable for	cont. 1/1 GN	trays 400x600	trays 400x600	trays 400x600
Volume of tabletop	5x1/6 GN h=150	16x1/6 GN h=150	-	-
Energy consumption	1026kWh	1237kWh	1174kWh	1174kWh
Temp. range	-2...+10°C	-2...+10°C	-2...+10°C	-2...+10°C
Cooling power	605W	605W	605W	605W
Power supply	297W/230V	297W/230V	297W/230V	297W/230V

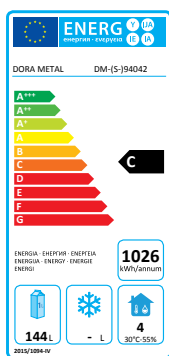

DM-94042
DM-S-94042 (fot)



DM-S-94051
(dedicated tabletop
DM-94050.6)

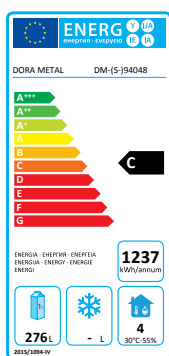

DM-94048
DM-S-94048 (fot)



DM-S-94049
(dedicated tabletop
DM-94050.9)

Options for refrigerated and freezer counters:

- Door lock (price for one module [0])
- Wheels (set of 4pcs in it 2 with brake) for 2- and 3-compartment counters
- Sliders for refrigerated and freezer counters (set left+right)
- Plasticized grate 1/1 GN
- Plasticized grate 2/3 GN
- Lighting of compartment in refrigerated counter with door
- One module [1] (one drawer) in refrigerated counters
- One module [2] (two drawers) in refrigerated counters
- One module [3] (three drawers) in refrigerated counters
- One module [1] (one drawer) in freezer counters
- One module [2] (two drawer) in freezer counters

Your Authorized Distributor

Dora Metal Sp. z o.o



Headquarters

- 📍 ul. Chodzieska 27
64-700 Czarnków
- ☎ tel. +48 67 255 20 42
fax. +48 67 255 25 15
- ✉ email: sales@dora-metal.pl

Regional Sales Department

- 📍 ul. Racjonalizacji 5
02-673 Warszawa
- ☎ tel. +48 22 847 65 86



Check also our offer of upright refrigerators and freezers::

- with solid door
- with glass door
- for bakeries
- for remote cooling systems
- different sizes, 1- and 2-door